

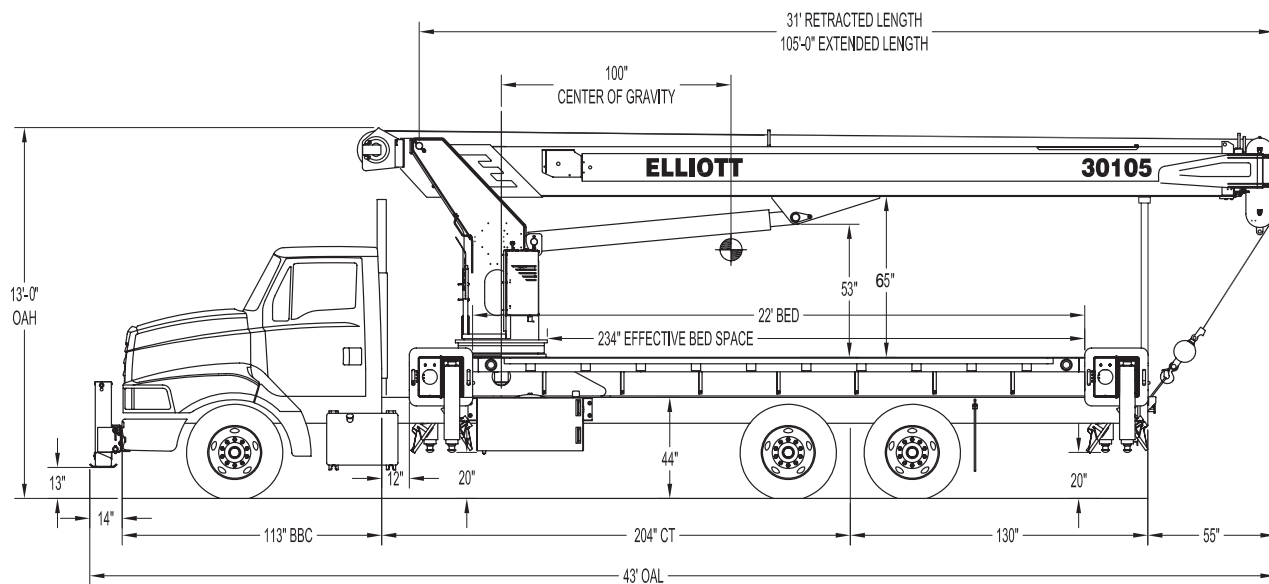

### 30105F SIDE VIEW DIAGRAM



- |                                  |                                     |                                 |                  |
|----------------------------------|-------------------------------------|---------------------------------|------------------|
| • <b>Maximum Vertical Reach</b>  | 162' / 49,4 m                       | • <b>Powered Boom Sections</b>  | 4                |
| • <b>Working Area</b>            | 180 Degrees Standard (360 Optional) | • <b>Overall Height</b>         | 13' / 4 m        |
| • <b>Lifting Capacity</b>        | 60,000 lbs / 27 216 kg              | • <b>Operator Controls</b>      | Rotating Standup |
| • <b>Boom Length</b>             | 105' / 32 m                         | • <b>Outrigger Type Front</b>   | Out-Down         |
| • <b>Crane Weight (Standard)</b> | 28,160 lbs / 12 733 kg              | • <b>Outrigger Spread Front</b> | 20' / 6 m        |
| • <b>Jib Lengths</b>             | 26', 26-45' / 8-13,7 m              | • <b>Outrigger Type Rear</b>    | Out-Down         |
| • <b>Winch Bare Drum Pull</b>    | 12,800 lbs / 5806 kg                | • <b>Outrigger Spread Rear</b>  | 20' / 6 m        |

## TECHNICAL SPECIFICATIONS

**Crane Capacity:** 60,000 lbs at 5' load radius.

**Maximum Tip Height:** 117' tip height (162' with optional 45' jib)

**Control Console:** Rotating turret single operator standup control station equipped with four single axis control levers for the main crane controls. Operator station includes LMI display, bubble level gauge, engine start/stop switch, signal horn button, variable speed throttle switch, lifting capacity chart, range diagram chart, boom angle indicator, system pressure gauge, 12V DC power source, and cup holder. Independent ground level electric operated outrigger controls.

**Boom:** Four-section fully proportional, high strength steel plated rectangular tube sections. A maximum boom tip height of 117' mounted on a truck. The boom nose contains one floating upper sheave and three lower sheaves. Assembly includes heavy-duty cylinder fittings, pivot pins, and replaceable wear pads.

**Winch:** Mounted at the base of the boom for a long fleet angle and flat level spooling of cable. Winch is driven by a planetary reducer and powered by a hydraulic motor. Burst-of-speed winch provides increased line speed. The winch brake is spring applied, pressure release design. Supplied with 425' of 9/16" diameter rotation resistant wire rope with a single line pull of 9,060 pounds, and a downhaul ball with swivel hook for single part line.

**Load Moment Indicator System:**

System senses hoist cylinder pressures, boom length and boom angle with hydraulic function lockout. The display console is equipped with a bar graph showing crane utilization, boom angle or boom length, a mode select controls for main boom and jib operation, and an anti-two block with an audio/visual warning and shut-off functions to limit hook-boom point contact.

Elliott Equipment Company reserves the right to change the specification of any unit at any time without prior notice. This brochure is only a statement of general specifications on the date of this publication. For more detailed info on specific Elliott trucks go to [www.elliottequip.com](http://www.elliottequip.com)

**Outriggers:** Two sets of out and down overframe outriggers with 20' span. Outriggers are configured for full span or mid span operation. Outriggers equipped with ball socket aluminum removable pads that stow on vertical outrigger legs.

**Frame:** Full length, all welded rigid 4-plate design sub-frame. Sub-frame allows for bolt-on addition of 22' bed wings, with top plate of subbase serving as a portion of the bed deck, to form a three-piece bed.

**Turret:** Reverse offset turret is one-piece weldment. Turret rotates on large diameter ball bearing.

**Rotation:** Hydraulic motor drives turret through double reduction planetary swing drive for 372-degree non-continuous rotation.

**Lift:** One double-acting long stroke cylinder provides smooth and stable boom elevation. Holding valve prevents boom from falling in event of hose failure.

**Boom Extension:** Incorporates a 2-stage hydraulic extension cylinder, attached to the largest boom section, with a proportional cable extension system driving the outermost sections.

**Hoses:** All high pressure hoses are wire braid reinforced with a minimum safety factor of 4 to 1.

**Cylinders:** All cylinders use microhoned cylinder tubing, chrome shafts, top grade packing and protective rod wipers. Cylinder-mounted holding valves provided on all load-holding cylinders.

**Hydraulic System:** Equipped with air-shift PTO, piston pump, SAE O-ring face seals on pressure lines, and a 10-micron return line filter. The control valve distributes all flow to hoist system, swing circuit, and other crane functions. System is closed center type.

**Oil Tank Capacity:** 120 gallon mounted to truck frame on roadside.

**Cab Equipment:** PTO switch with indicator lights installed in truck cab. U/L approved 5:BC dry chemical fire extinguisher installed in truck cab.

**Operators Manual & Video:** Two CD copies and one hard copy of operation, maintenance, safety and parts manual provided with each unit. Operational and safety video provided at delivery.

**Installation:** Unit installed on chassis, painted, system and tank filled with oil, tested, inspected, and ready to operate.

**Standard Paint:** Paint turret and boom white, outriggers red, and bed and boxes black. Top of bed painted with black nonskid surface.

**Bumper:** Bureau of Motor Carrier Safety rear bumper.

**Weight:** Approximately 28,160 lbs. with 22' steel-floor bed less truck.

**Truck Chassis Required:** Approx. 204" C.T. RBM 3,300,000 in-lb. per rail, 20,000 lb. front axle and 60,000 lb. GVWR required. Trucks must have front frame extension, 12V electrical system with high capacity alternator, cab clearance stop/tail/backup lights, and I.D. lamps. Recommended GVWR is minimum for BoomTruck with flatbed only. Contact factory when additional equipment is to be added.

**Options:**

45' or 26' Telescopic Jib  
Radio Remote Controls  
Gravity-Leveled Steel Basket  
Tool Box Configurations  
Front Jack for 360 Degree Crane Operation  
Much more...

**LOAD CHART - MAIN BOOM, FULL-SPAN OUTRIGGERS**

MAIN BOOM LOAD RATINGS WITH FULLY EXTENDED OUTRIGGERS														
MAIN BOOM LOAD RATINGS														
LOAD RATINGS IN lbs WITH OUTRIGGERS AND STABILIZERS EXTENDED														
LOAD RADIUS IN FEET	LOADED BOOM ANGLE	31-ft	LOADED BOOM ANGLE	A 46-ft	LOADED BOOM ANGLE	B 58-ft	LOADED BOOM ANGLE	C 70-ft	LOADED BOOM ANGLE	D 82-ft	LOADED BOOM ANGLE	E 94-ft	LOADED BOOM ANGLE	F 105-ft
5	80	60,000												
6	78	48,000												
8	74.2	38,600	79.2	32,000										
10	70.3	32,000	76.6	28,000										
12	66.2	27,500	74	26,000	77.4	25,300								
14	62	24,000	71.3	24,000	75.4	23,700	78	21,700						
16	57.6	20,800	68.6	22,500	73.3	22,200	76.3	20,400	78.3	17,500				
18	52.9	17,900	65.8	21,000	71.1	20,600	74.5	19,000	76.9	16,600	78.6	15,000		
20	47.8	15,600	62.9	19,000	69	19,100	72.8	17,800	75.4	15,500	77.3	13,600		
22	42.3	13,100	60	17,000	66.8	17,600	71	16,500	74	14,500	76.1	12,800	78	8,400
25	32.2	10,200	55.3	14,000	63.5	15,300	68.4	14,600	71.7	13,000	74.2	11,800	76.1	8,400
30			46.9	11,000	58.1	12,300	64.2	11,500	68.3	11,500	71.2	10,200	73.2	8,400
35			37.8	9,000	51.8	9,900	59.4	9,300	64.4	9,300	67.9	8,900	70.3	8,400
40			24.3	6,300	44.9	8,700	54.4	7,700	60.3	7,650	64.5	7,650	67.4	7,350
45					36.9	7,500	49	6,500	56.1	6,450	61	6,400	64.3	6,250
50					26.7	6,000	43.1	5,500	51.7	5,450	57.4	5,400	61.2	5,200
55							36.3	4,700	46.9	4,650	53.6	4,600	58	4,200
60							28.1	4,050	41.7	4,000	49.6	3,950	54.6	3,300
65							16.1	3,500	35.9	3,450	45.4	3,400	51.1	2,950
70									30	3,000	40.7	2,800	47.4	2,350
75									19.9	2,300	35.6	2,000	43.5	1,850
80											29.7	1,000	39.2	1,450
85											22.3	600	34.5	1,150
90													29.1	850
95													22.4	600
0		8,800	0	6,200	0	4,100								
DEDUCTIONS FOR STOWED JIB (lbs)	850		600		450		400		350		300		250	
	550		350		300		250		200		150		150	







  

JIB LOAD RATINGS						
LOAD RATINGS IN lbs WITH OUTRIGGERS AND STABILIZERS EXTENDED						
LOAD RADIUS IN FEET	LOADED BOOM ANGLE	26-ft FIXED LENGTH JIB		26-45 ft EXTENDABLE JIB		
		26-ft JIB	LOADED BOOM ANGLE	26-ft JIB RETRACTED	LOADED BOOM ANGLE	45-ft JIB EXTENDED
30	78.7	4,750	78.5	4,500		
35	76.5	4,350	76.3	4,100	77.4	2,600
40	74.3	3,950	74.1	3,700	75.4	2,500
45	72	3,450	71.7	3,200	74	2,400
50	69.5	3,050	69.3	2,800	72.2	2,250
55	67.1	2,650	66.8	2,400	70.3	2,050
60	64.6	2,350	64.3	2,100	68.3	1,900
65	62	2,050	61.7	1,800	66.2	1,750
70	59.4	1,850	59.1	1,600	64.2	1,600
75	56.7	1,650	56.4	1,400	62	1,400
80	53.9	1,450	53.6	1,200	59.7	1,200
85	51	1,250	50.6	1,000	57.3	1,100
90	47.8	1,050	47.5	800	55.1	1,000
95					52.6	850
100					49.6	500

ELLIOTT EQUIPMENT CO. SUPPLIED  
 LOADLINE EQUIPMENT DEDUCTIONS:  
 DOWNHAUL WEIGHT .....180 lbs  
 ONE SHEAVE BLOCK.....375 lbs  
 TWO SHEAVE BLOCK.....640 lbs  
 THREE SHEAVE BLOCK.....870 lbs  
 AUXILIARY SHEAVE.....100 lbs

DEDUCTIONS FOR STOWED EXTENDABLE JIB (lbs)							DEDUCTIONS FOR STOWED FIXED LENGTH JIB (lbs)	
1-PART LINE	2-PART LINE	3-PART LINE	4-PART LINE	5-PART LINE	6-PART LINE	7-PART LINE	NOTICE	
							-DO NOT DEADEND LINE BLOCK AGAINST BOOM TIP WHEN EXTENDING BOOM -KEEP AT LEAST 3 WRAPS OF LOADLINE ON THE WINCH DRUM AT ALL TIMES. -USE ONLY 1/2" DIAMETER WIRE ROPE, AS SPECIFIED BELOW, WITH THE PROPER BREAKING STRENGTH LISTED. -INSTALL HOOK OR SYSTEM MUST BE IN GOOD OPERATING CONDITION BEFORE OPERATING CRANE. SEE OPERATION & SAFETY MANUAL. <small>100% OF RATED BREAKING STRENGTH                      100% OF RATED BREAKING STRENGTH                      100% OF RATED BREAKING STRENGTH</small>	
MAX PULL: 9,600 lbs	19,200 lbs	28,800 lbs	38,400 lbs	48,000 lbs	57,600 lbs	60,000 lbs		
MAX PULL: 9,060 lbs	18,120 lbs	27,180 lbs	36,240 lbs	45,300 lbs	54,360 lbs	60,000 lbs		

CRANE MEETS ASME B30.1 REQUIREMENTS AT TIME OF MANUFACTURE DO NOT PRINT OVER ANY LABELS 11/13/10 06146

**LOAD CHART - MAIN BOOM, MID-SPAN OUTRIGGERS**

**MAIN BOOM LOAD RATINGS WITH OUTRIGGERS AT MID-SPAN POSITION**

MAIN BOOM LOAD RATINGS													JIB LOAD RATINGS									
LOAD RATINGS IN lbs WITH OUTRIGGERS AND STABILIZERS EXTENDED													LOAD RATINGS IN lbs WITH OUTRIGGERS AND STABILIZERS EXTENDED									
LOAD RADIUS IN FEET	LOADED BOOM ANGLE	31-ft		46-ft		58-ft		70-ft		82-ft		94-ft		105-ft		LOAD RADIUS IN FEET	LOADED BOOM ANGLE	26-ft FIXED LENGTH JIB		26-45 ft EXTENDABLE JIB		
		BOOM ANGLE	LOAD	BOOM ANGLE	LOAD	BOOM ANGLE	LOAD	BOOM ANGLE	LOAD	BOOM ANGLE	LOAD	BOOM ANGLE	LOAD	BOOM ANGLE	LOAD			BOOM ANGLE	LOAD			
5	80	60,000														30	78.7	4,750	78.5	4,500		
6	78	48,000														35	76.5	4,350	76.3	4,100	77.4	2,600
8	74.2	38,600	79.2	32,000											40	74.3	3,950	74.1	3,600	75.4	2,500	
10	70.3	32,000	76.6	28,000											45	72	2,950	71.7	2,700	74	2,400	
12	66.2	27,500	74	26,000	77.4	25,300									50	69.5	2,200	69.3	1,900	72.2	2,250	
14	62	21,300	71.3	24,000	75.4	23,700	78	21,700							55	67.1	1,550	66.8	1,300	70.3	2,000	
16	57.6	19,500	68.6	20,000	73.3	20,000	76.3	20,400	78.3	17,500					60	64.6	1,050	64.3	800	68.3	1,450	
18	52.9	15,800	65.8	15,800	71.1	16,600	74.5	16,300	76.9	16,600	78.6	15,000			65					66.2	1,050	
20	48.9	12,200	62.9	13,000	69	13,300	72.8	13,400	75.4	13,900	77.3	13,600			70					64.2	750	
22	42.3	9,500	60	10,500	66.8	11,000	71	11,000	74	11,200	76.1	11,000	78	8,400								
25	33.8	7,800	55.3	8,200	63.5	8,300	68.7	8,750	72	8,800	74.2	9,000	76.1	8,400								
30			46.9	5,900	58.1	6,100	64.2	6,150	68.3	6,200	71.2	6,400	73.2	6,500								
35			37.8	4,000	51.8	4,300	59.4	4,350	64.4	4,400	67.9	4,600	70.3	4,700								
40			24.3	2,800	44.9	3,100	54.4	3,150	60.3	3,200	64.5	3,300	67.4	3,400								
45					36.9	2,200	49	2,250	56.1	2,300	61	2,400	64.3	2,500								
50					26.7	1,450	43.1	1,550	51.7	1,600	57.4	1,700	61.2	1,800								
55							36.3	1,000	46.9	1,050	53.6	1,150	58	1,200								
60									41.7	650	49.6	700	54.6	750								
0		5,200	0	2,200	0	650																
DEDUCTIONS FOR STOWED JIB (lbs)		850		600		450		400		350		300		250	DEDUCTIONS FOR STOWED EXTENDABLE JIB (lbs)							
		550		350		300		250		200		150		150	DEDUCTIONS FOR STOWED FIXED LENGTH JIB (lbs)							

ELLIOTT EQUIPMENT CO. SUPPLIED  
 LOADLINE EQUIPMENT DEDUCTIONS:  
 DOWNHAUL WEIGHT .....180 lbs  
 ONE SHEAVE BLOCK.....375 lbs  
 TWO SHEAVE BLOCK.....640 lbs  
 THREE SHEAVE BLOCK.....870 lbs  
 AUXILIARY SHEAVE.....100 lbs

1-PART LINE	2-PART LINE	3-PART LINE	4-PART LINE	5-PART LINE	6-PART LINE	7-PART LINE	NOTICE
							<ul style="list-style-type: none"> <li>- DO NOT DEADHEAD LINE BLOCK AGAINST BOOM TIP WHEN EXTENDING BOOM.</li> <li>- KEEP AT LEAST 5 WRAPS OF LOADLINE ON THE WINCH DRUM AT ALL TIMES.</li> <li>- USE ONLY 9/16" DIAMETER WIRE ROPE, AS SPECIFIED BELOW, WITH THE PROPER BREAKING STRENGTHS LISTED.</li> <li>- ANTI-TWO-BLOCK SYSTEM MUST BE IN GOOD OPERATING CONDITION BEFORE OPERATING CRANE. SEE OPERATION &amp; SAFETY MANUAL.</li> </ul>
MAX PULL: 9,600 lbs	19,200 lbs	28,800 lbs	38,400 lbs	48,000 lbs	57,600 lbs	60,000 lbs	9/16" - 6 x 37 IWRC (3.5:1 S.F.) 33,600-lbs. BREAKING STRENGTH
MAX PULL: 9,060 lbs	18,120 lbs	27,180 lbs	36,240 lbs	45,300 lbs	54,360 lbs	60,000 lbs	9/16" - SPIN RESISTANT (5:1 S.F.) 45,300-lbs. BREAKING STRENGTH

CRANE MEETS ASME B30.5 REQUIREMENTS AT TIME OF MANUFACTURE

DO NOT PAINT OVER ANY LABELS

1113150 061406

**RANGE CHART - MAIN BOOM + JIB, FULL-SPAN OUTRIGGERS**

**RANGE DIAGRAM WITH FULL SPAN OUTRIGGERS**

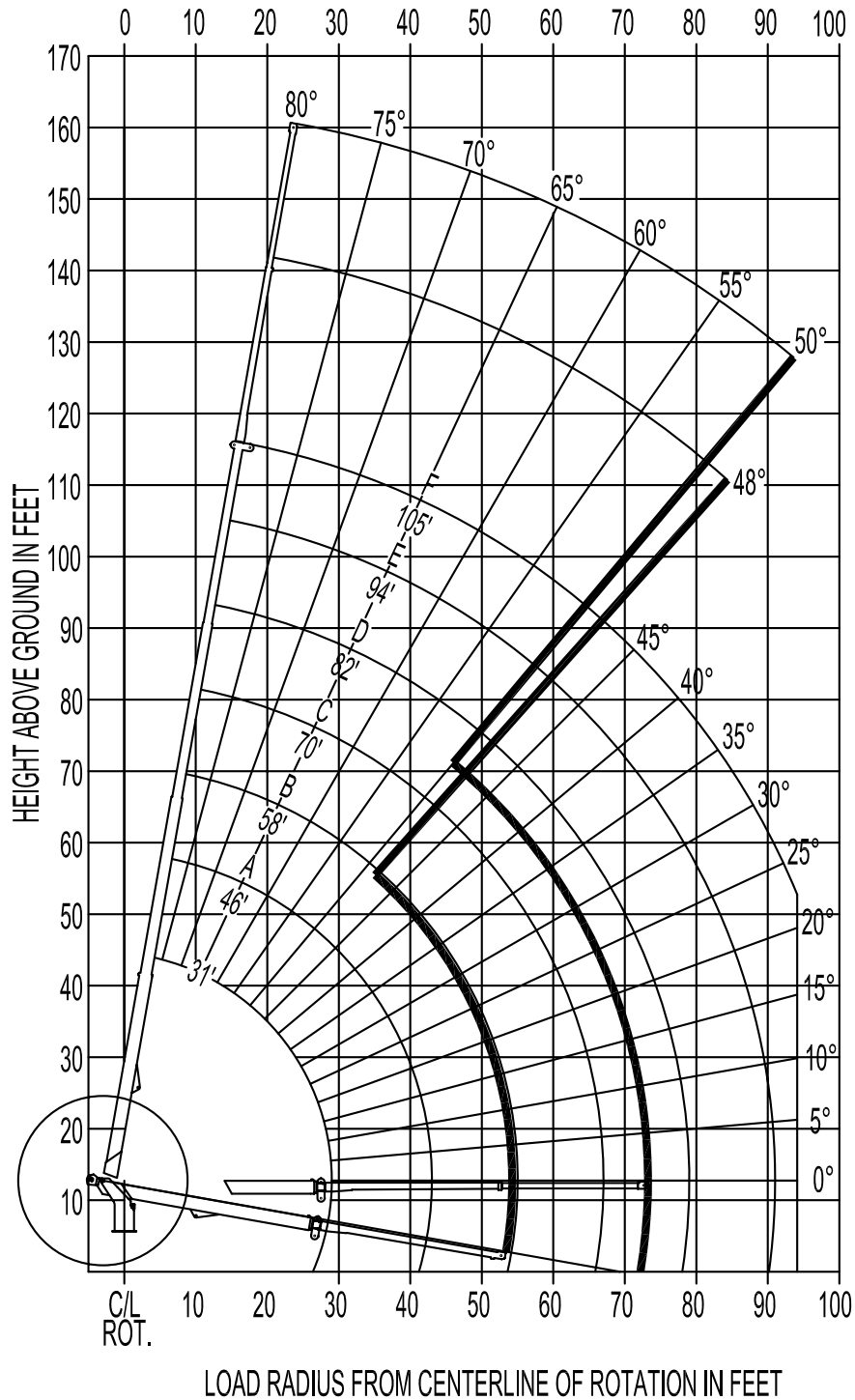

**RANGE CHART - MAIN BOOM + JIB, MID-SPAN OUTRIGGERS**

**RANGE DIAGRAM WITH OUTRIGGERS AT MID-SPAN POSITION**

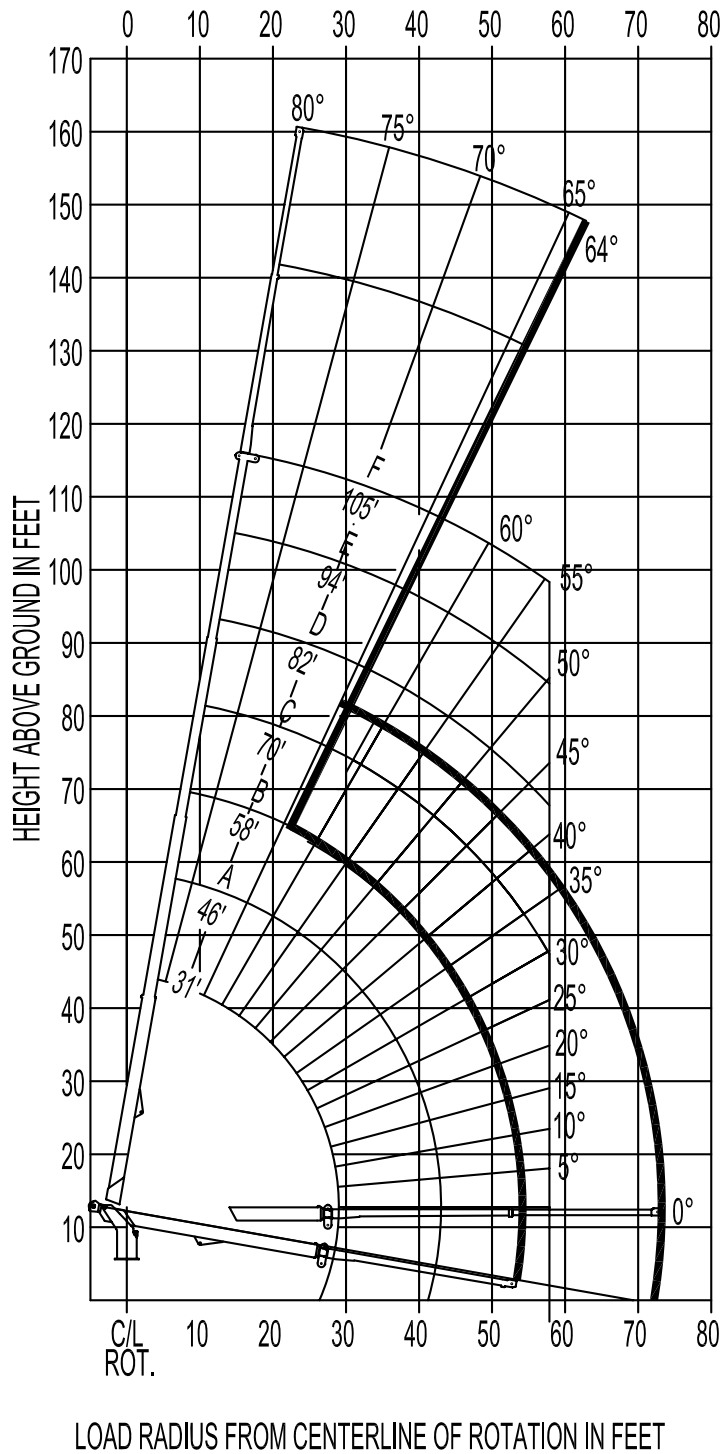

## TRUCK CHASSIS SPECIFICATIONS

	30105F BoomTruck
Wheelbase (WB)	268" / 681 cm
Cab to Tandem (CT)	204" / 518 cm
Cab to End of Frame (EOF)	334" / 594 cm
Frame Section Modulus	30.0 in3-110,000 psi
Front Axle Gross Weight Rating	20,000 lb / 9,071 kg
Rear Axle Gross Weight Rating	40,000 lb / 18,143 kg
Integral Front Frame Rails	Required for Front Stabilizer

Chassis data is minimum general requirements-not for engineering.  
 Actual dimensions and truck data will depend on truck selection and axle configuration.  
 \*Minimum chassis weight is required to meet 85% stability requirements.

## OPTIONS



### Radio Remote Control

Interference protected radio remotes let you get closer to your work and have full control over your machine. Includes battery charging feature and optional LMI screen.



### Tool Boxes

Optional tool boxes and bed storage can accommodate any storage need for tools, work materials and more.

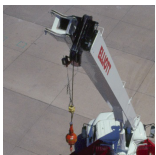

### Pin-On Jib Attachments

One piece & two piece telescoping or fixed jibs that stow on the side of the boom for easy placement while on the worksite.



### Hook Block for Multi-Part Line

Elliott can install a 2-3 part hook block or a 4 part-hook block to improve lifting capabilities. The block can be stored at the rear of the bed.



### Continuous Boom Rotation

Add the convenience of 360 degree continuous rotation by adding a special boom rotation bearing for swinging without stops.

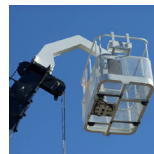

### Gravity Levelled Basket

Elliott's pin-on work platform pins onto the boom for easy installation and removal. Gravity leveling and mechanical rotation makes it a great accessory for any worksite.



### Digger / Auger Attachment

Dig faster and deeper with Elliott's auger attachment, offering 44' of digging range and a hydraulically powered auger that stows on the boom.



### Body Mounted Hose Reels and Circuits

Let us work with you to customize your tool compatibility by adding hose reels or hydraulic circuits to the crane bed.